

## ECHO

### Fully Adjustable LED Framelight

- // Incorporates Tridonic LED module and driver system
- // UGR19 and ECA compliant variants
- // Multifaceted 40° reflector as standard
- // Alternative reflector and beam options
- // Emergency and DALI dimming options
- // Also available in 3000K
- // Life up to >55,000 hours (L70/F10)
- // CRI>80 as standard, CRI>90 option available
- // 5-year warranty
- // Manufactured in UK



Product Code	Lens	LED Wattage	Lumen Output	Lumen/Watt	Colour Temperature	Dimensions (mm)	Cutout (mm)
ECH1/15/XY	1x	8W	1055	131	4000K	189 x 189 x 145	180 x 180
ECH1/18/XY	1x	13W	1787	130	4000K	189 x 189 x 145	180 x 180
ECH1/24/XY	1x	19W	2442	127	4000K	189 x 189 x 145	180 x 180
ECH1/30/XY	1x	27W	3252	117	4000K	189 x 189 x 145	180 x 180
ECH2/15/XY	2x	8W	1055	131	4000K	348 x 189 x 145	339 x 180
ECH2/18/XY	2x	13W	1787	130	4000K	348 x 189 x 145	339 x 180
ECH2/24/XY	2x	19W	2442	127	4000K	348 x 189 x 145	339 x 180
ECH2/30/XY	2x	27W	3252	117	4000K	348 x 189 x 145	339 x 180
ECH3/15/XY	3x	8W	1055	131	4000K	504 x 189 x 145	495 x 180
ECH3/18/XY	3x	13W	1787	130	4000K	504 x 189 x 145	495 x 180
ECH3/24/XY	3x	19W	2442	127	4000K	504 x 189 x 145	495 x 180
ECH3/30/XY	3x	27W	3252	117	4000K	504 x 189 x 145	495 x 180

\*This range is only available as Non-Dimmable and 4000K

### Technical Drawings

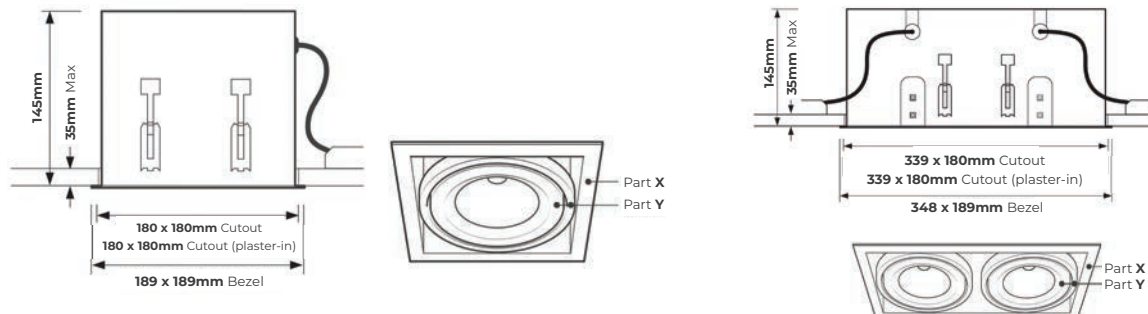





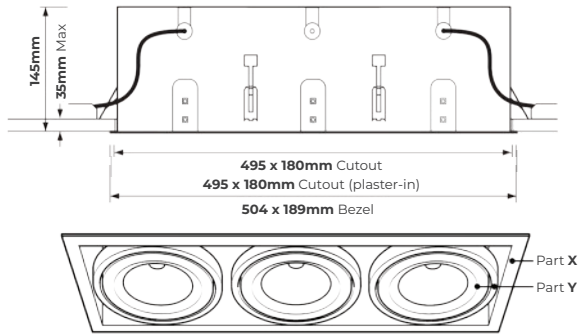







## ECHO - OPTIONS AND ACCESSORIES

### Technical Drawing



Option Code	Description
/M	3 Hour Maintained Emergency
/MZ	3 Hour DALI Maintained Emergency
/DALI	DALI/DSI Dimmable Driver
/BTC	Casambi Dimmable
/CRI90	CRI>90
/PI	Plaster-In Trimless Bezel
/PART A	W = White RAL9016 B = Black RAL9005
/PART B	W = White RAL9016 B = Black RAL9006
/MF25	25° Multi-Faceted Reflector
/MF60	60° Multi-Faceted Reflector
/SP40	40° Specular Reflector
/SA50	50° Satin Reflector
Product Variation (state required specification)	

### Options

 <p><b>/M</b> 3 Hour Maintained Emergency</p>	 <p><b>/MZ</b> 3 Hour DALI Maintained Emergency</p>	 <p><b>/BTC</b> Casambi Dimmable</p>	 <p><b>/PI</b> Plaster-In Trimless Bezel</p>
 <p><b>/WW</b> White, White</p>	 <p><b>/BB</b> Black, Black</p>	 <p><b>/WB</b> White, Black</p>	 <p><b>/BW</b> Black, White</p>
 <p><b>/MF25</b> 25° Multi-Faceted Reflector</p>	 <p><b>/MF60</b> 60° Multi-Faceted Reflector</p>	 <p><b>/SP40</b> 40° Specular Reflector</p>	 <p><b>/SA50</b> 50° Satin Reflector</p>

For optional features, please include the option code suffix with the product code when ordering.